

This document is intended as a reference guide for installing and using a BENDER RCM420 ground fault monitor. This document includes installation, setup, and usage instructions. For complete details, including installation, setup, settings, and troubleshooting, refer to the RCM420 user manual, document number TGH1410en. This document is intended as a supplement and not a replacement to the complete user manual.

Only qualified maintenance personnel shall operate or service this equipment. These instructions should not be viewed as sufficient for those who are not otherwise qualified to operate or service this equipment. This document is intended to provide accurate information only. No responsibility is assumed by BENDER for any consequences arising from use of this document.



Applicable Devices

This document applies to the following devices:

- RCM420-D-1
- RCM420-D-2

For other versions of the RCM420, including models with analog outputs, refer to the RCM420-DM series installation bulletin, document NAE1048220.

Installation

Mounting

RCM420 series devices may be DIN rail mounted, or screw mounted using the black clips located on the top and bottom of the device. Screw mounting requires an extra black clip (article number B98060008, sold separately).

Wiring - General

Refer to figure 1 for wiring the RCM420. Refer to section "Wiring - Current Transformers" for detailed information regarding connecting current transformers.

When routing the circuit through the current transformer, whether it is single-phase or three-phase, ensure all conductors are routed through, including the neutral if it is being used. Do not place the ground conductor through the CT.

Only the following BENDER current transformers may be used with an RCM420: W0-S20, W1-S35, W2-S70, W3-S105, W4-S140, W5-S210, W20, W35, W60, W120, W210, WR series, WS series. Current transformers with a part number ending in "8000" may not be used. Use AWG 22, shielded cable. The maximum length is 130 feet. Current transformers may be screw mounted with the included mounting feet. Refer to RCM420 series user manual for complete technical details.

! DANGER

HAZARD OF ELECTRIC SHOCK, EXPLOSION, OR ARC FLASH

- Disconnect all power before servicing.
- Observe all local, state, and national codes, standards, and regulations.

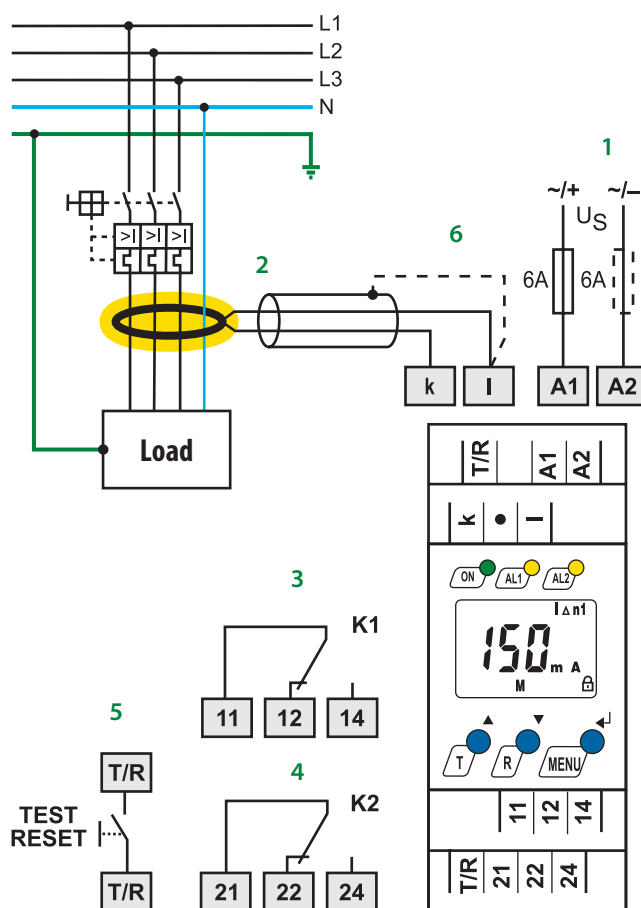

Figure 1 - RCM420 wiring diagram

1. External supply voltage; 6A fuse recommended for internal device protection
2. Connection to current transformer. All phases, including the neutral if it is being used, must be routed through the CT. Do not route the ground conductor through the CT.
3. Alarm relay K1: SPDT contact
4. Alarm relay K2: SPDT contact
5. External test / reset terminal (N/O contact; momentary closure for reset, closure for > 1.5 s for test)
6. Connection required for shielded cable

Wiring - Contacts

Using a normally closed or normally open contact utilizes two factors: wiring out of the proper terminal, and setting the respective contact to normally energized or deenergized operation. Refer to the chart below for relay conditions. For changing the energized state of the contact, refer to "Figure 8 - Contact operation" on the reverse side of this document.

Device Relay Conditions			
Relay Operation Setting	Device Alarm State	K1 STATE	K2 STATE
Normally deenergized mode (N/D) Non-failsafe mode "N/O" in device settings menu	Power ON, normal state (no alarms)	11-12 CLOSED 11-14 OPEN	21-22 CLOSED 21-24 OPEN
	Power OFF	11-12 CLOSED 11-14 OPEN	21-22 CLOSED 21-24 OPEN
Energized in the alarm state Relay will switch when the alarm is activated.	Power ON, normal state (no alarms)	11-12 OPEN 11-14 CLOSED	21-22 OPEN 21-24 CLOSED
	Power OFF	11-12 CLOSED 11-14 OPEN	21-22 CLOSED 21-24 OPEN
Normally energized mode (N/E) Failsafe mode "N/C" in device settings menu	Power ON, normal state (no alarms)	11-12 OPEN 11-14 CLOSED	21-22 OPEN 21-24 CLOSED
	Power ON, alarm state	11-12 CLOSED 11-14 OPEN	21-22 CLOSED 21-24 OPEN

Front Panel Display

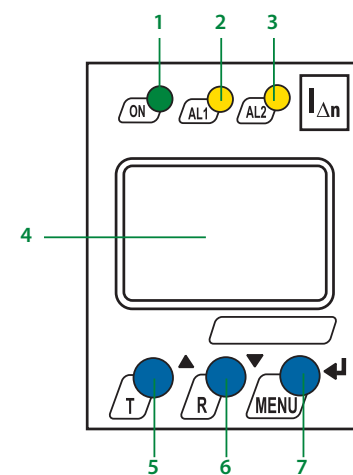

Figure 2 - RCM420 front display

1. LED "ON" (green): Illuminates when power is applied to the device. Flashes when the CT connection alarm is active.
2. LED "AL1" (yellow): Illuminates when the prealarm is activated. Flashes when the CT connection alarm is active.
3. LED "AL2" (yellow): Illuminates when the main alarm is activated. Flashes when the CT connection alarm is active.
4. Backlit LCD display
5. TEST / UP button: Activates self-test / scrolls up inside main menu.
6. RESET / DOWN button: Resets device / scrolls down inside main menu.
7. MENU / ENTER button: Activates main menu / Confirms (momentary push) or goes back a step (held > 1.5 s) inside main menu.

Dimensions

Dimensions in inches (mm).

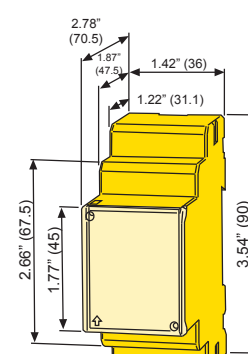

Figure 4 - Setting main alarm trip value

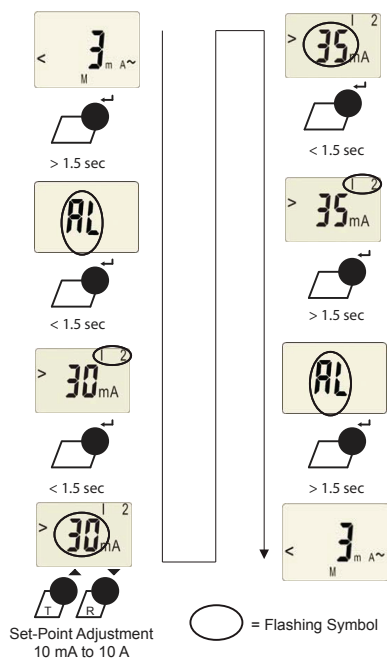

Figure 5 - Setting prealarm trip value

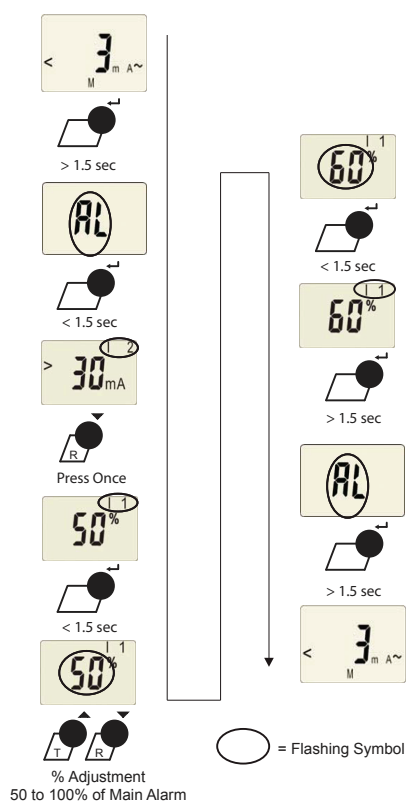

Figure 6 - Changing Time Delays

Four separate time delays are available:

- t_{on1} - Response delay, prewarning
- t_{on2} - Response delay, main alarm
- t - Startup delay
- t_{off} - Delay on release

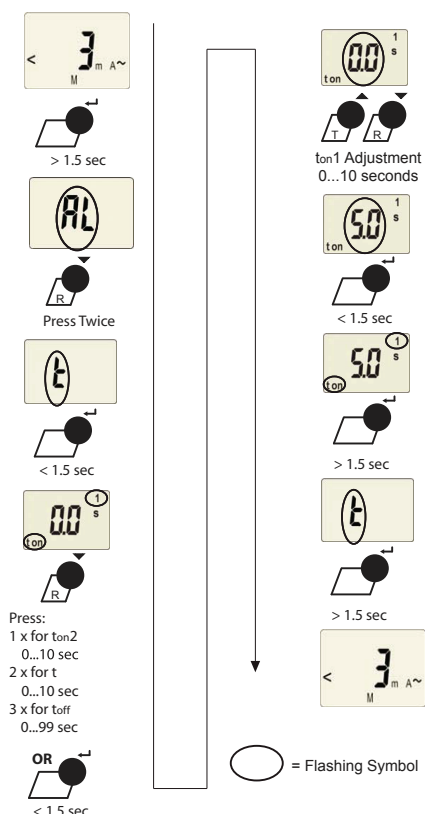

Figure 7 - Latching behavior (fault memory)

Changing this setting to "ON" will cause the RCM420 to latch in the event of an alarm, and require a manual reset if the alarm clears. Changing this setting to "OFF" will cause the RCM420 to automatically reset if the alarm clears. Changing this setting to "CON" will cause the RCM420 to latch, and additionally, if power is lost to the RCM420, it will return to the latched state when power is restored.

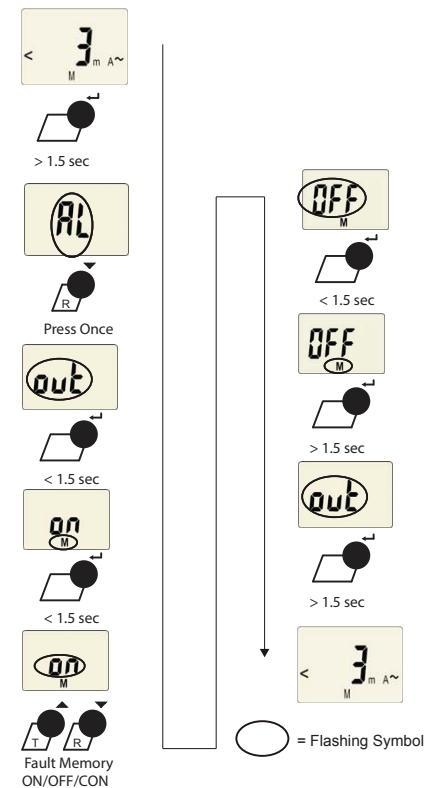
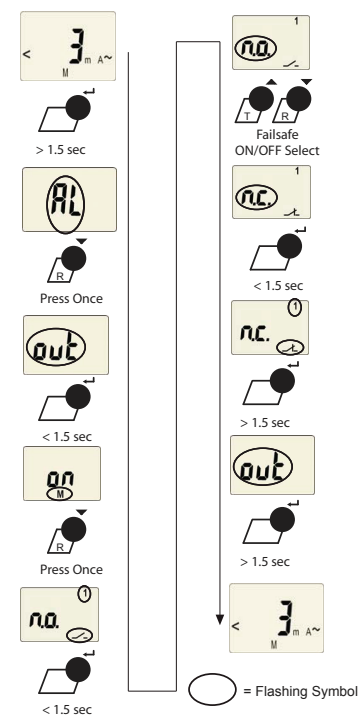

Figure 8 - Contact operation

Use this option to change the behavior of the contacts between normally deenergized (non-failsafe) mode and normally energized (failsafe) mode. The two SPDT contacts may be changed individually. Note that the RCM420 labels normally deenergized operation as "N/O" and normally energized operation as "N/C"; utilizing a normally open or normally closed contact only depends on which contact output is wired.



Menu Flow Chart for Common Settings

Figures 4 through 8 above contain flow charts for modifying commonly used features and settings in the RCM420's main menu. Not all available features are listed in this document. For more information, consult the RCM420 user manual.

Menu Legend

