NGRM500 (HRG) NGRM550 (LRG)

Neutral Grounding Resistor Monitor



NGRM500 (HRG) NGRM550 (LRG)

Neutral Grounding Resistor Monitor



Device features

- Determination of R_{NGR} with passive and active measurement methods
- Continuous monitoring of the R_{NGR} even if the installation is de-energized;
- Alarm or trip on ground fault
- Monitoring of the current I_{NGR}
- Monitoring of the voltage U_{NGR}
- Ethernet communication
- Web server
- Language selection (German, English GB and US, Spanish, French)
- Test button (internal, external) with/without tripping
- FFT analysis of neutral current and voltage
- Pulser control for manual ground fault location
- Relay outputs for detection of ground faults and resistor faults
- Relay output for shutdown of the installation after a configurable time
- Can be combined with RCMS... for automatic shutdown of feeders
- Graphical user interface
- Wide supply voltage range for operating the NGR monitor
- Range of use up to 2000 m AMSL
- Fault/History memory
- Analogue output of measured values (0...10 V, 4...20 mA, etc., selectable parameters)
- Password protection
- Tripping on RMS, fundamental component signal or harmonics
- Detection of AC and DC ground faults
- Variants High Resistance Grounded (HRG), Low Resistance Grounded (LRG)

Certifications



UL File Number: E493737, E173157

	HRG		LRG	
	NGRM500	NGRM700	NGRM550	NGRM750
U_{sysLL}	400...25000V			
$I_{NGR nom}$	0...100 A		10...2000 A	
$R_{NGR nom}$	15...5000 Ω		0,1...200 Ω	

Product description

The NGRM500 is only intended for use in high-resistance grounded systems. The NGRM550 is only intended for use in low-resistance grounded systems. In these systems, the NGRM5... monitors

- the current through the neutral-grounding resistor (NGR),
- the voltage between the star point of the transformer and ground (voltage drop across the NGR),
- the condition of the neutral grounding resistor (NGR).

i *Systems with a resistance-grounded star point can be used when an **interruption of the power supply would involve excessive costs due to production stoppage** (e.g. automotive production, chemical industry). The ground fault that occurs between a phase and ground does not lead to a failure of the power supply in these systems. A ground fault must be detected and eliminated as quickly as possible, since the occurrence of another ground fault in a second phase would lead to a tripping of the overcurrent protective device.*

In order to meet the requirements of applicable standards, customised parameter settings must be made on the equipment in order to adapt it to local equipment and operating conditions.

Function

The NGRM5... monitors NGR resistance R_{NGR} , neutral voltage U_{NGR} and current I_{NGR} . NGR resistance is monitored using an active and a passive procedure:

active The device generates an active test pulse and measures R_{NGR} even if the installation is de-energised.

passive The resistance R_{NGR} is determined when I_{NGR} or U_{NGR} exceeds an internal threshold. The device measures the existing current and voltage and calculates R_{NGR} .

In the case of the "auto" method, monitoring switches automatically between "active" and "passive" when the measured current or voltage value exceeds or falls below the internal threshold. The threshold is 15 % of the nominal value and can be adjusted by Bender if required.

A shorted or open NGR is reliably detected in an energized as well as a de-energized installation with the active measurement method.

When the "passive" method is selected, no switching of the monitoring takes place. The NGR is not monitored if the installation is shut down or the current and voltage are too low.

The measurement method can be selected as a set point or via the configurable digital input I1 if the NGR method "external" has been selected (for software versions from July 2021).

Should the use of frequency inverters lead to interferences with the R_{NGR} measured value during the active measurement, a filter for active resistance measurement can be added. To this end, 3 pre-defined filters (weak, medium, strong) have been implemented. In addition, the filter parameters can be adapted individually in the setting "Customer-specific".

The NGR-fault relay switches from the operating state (selectable as fail-safe or non-failsafe) to the alarm state when the measured resistance R_{NGR} is outside of the configured thresholds.

A ground fault is signalled via the corresponding ground-fault relay and the "GROUND FAULT" LED when I_{NGR} or U_{NGR} exceeds the selectable thresholds. After the adjustable time delay has elapsed, the trip relay operates. After the ground fault has been eliminated, the installation can be restarted either automatically or manually, depending on the configuration.

A connection to installations ranging from 400 V...25 kV is possible via the appropriate CD-series coupling device. I_{NGR} is measured with **measuring current transformers** with a 5 A or 50 mA secondary rating.

User interface FP200-NGRM

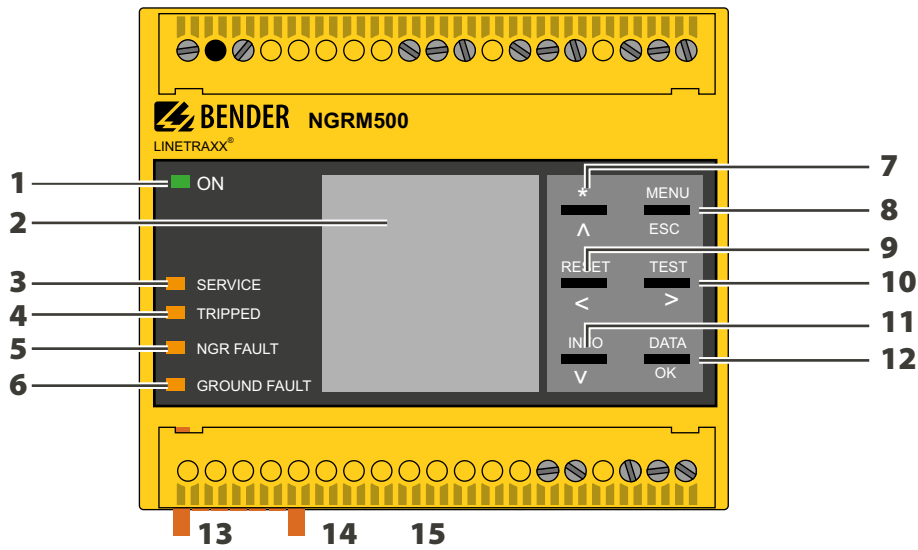

Display elements

- 1 - **ON** Operation LED, green; on when power supply is available
- 2 - The LC display shows device and measurement information.
- 3 - **SERVICE** The LED is on when there is either a device fault or a connection fault, and when the device is in maintenance mode.
- 4 - **TRIPPED** The LED is on when the trip relay has been tripped due to an NGR fault, ground fault or a device error.
- 5 - **NGR FAULT** The LED flashes in case of a prewarning: NGR fault detected, NGR fault relay has tripped, trip relay has not tripped yet ($t_{NGR\ trip}$ elapses). The LED is on when an NGR fault has been detected. Trip relay and NGR-fault relay have tripped.
- 6 - **GROUND FAULT** The LED flashes in case of a prewarning: ground fault detected, ground-fault relay has tripped, trip relay has not tripped yet ($t_{GF\ trip}$ elapses). The LED is on: ground fault detected, trip relay has tripped (if configured).

Device buttons

- 7 - \wedge Navigates up in a list or increases a value.
- 8 - **MENU** Opens the device menu.
- ESC** Cancels the current process or navigates one step back in the device menu.
- 9 - **RESET** Confirms and resets alarms.
- <** Navigates backwards (e.g. to the previous setting step) or selects parameter.
- 10 - **TEST** Starts the device self test.
- >** Navigates forwards (e.g. to the next setting step) or selects parameter.
- 11 - **INFO** Shows information.
- v** Navigates down in a list or reduces a value.
- 12 - **DATA** Indicates data and values.
- OK** Confirms an action or a selection.

Analogue and digital I/O configuration

- 13 - **X1** Interface X1
- 14 - **ETH** Ethernet interface
- 15 - **R on/off** Terminating resistor for A/B (Modbus RTU)
- Buzzer** Active in case of alarm and/or test

Connection: Star connection

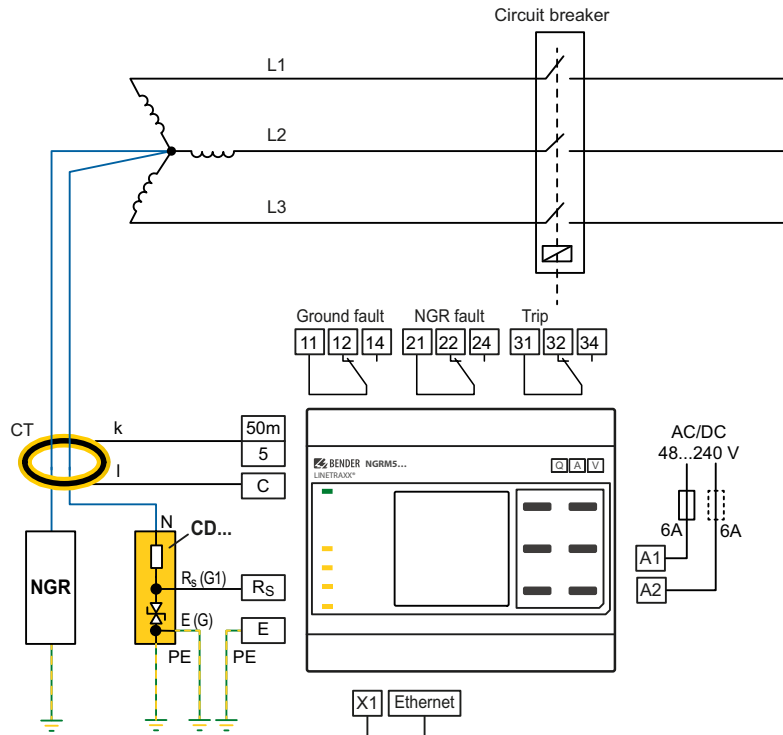

i The "N" connection of the CD-series coupling device should be as close to the transformer star point as possible.

Connection: Star connection with pulser

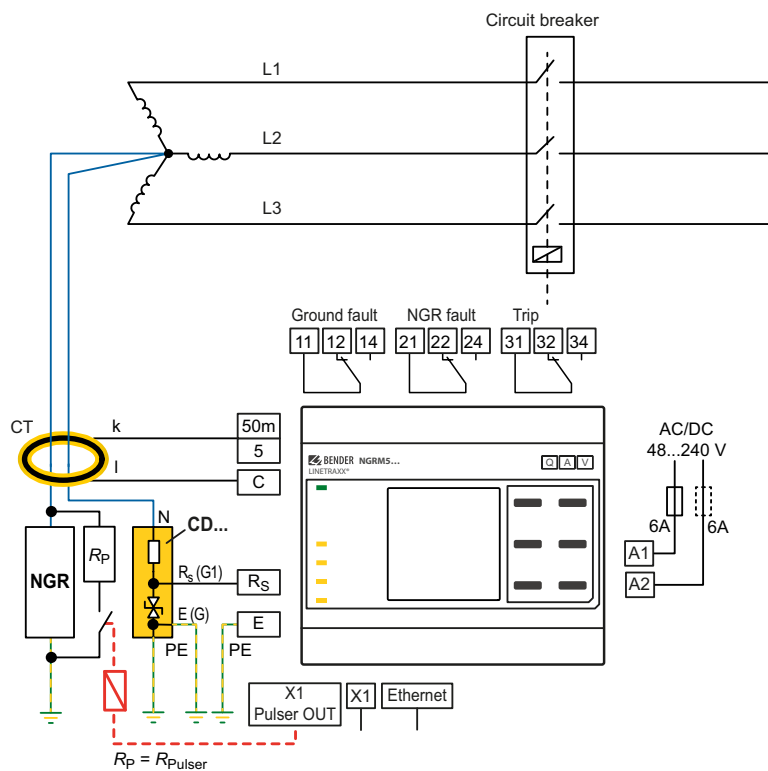

i The "N" connection of the CD-series coupling device should be as close to the transformer star point as possible. An intermediate relay may be required between the power contactor of the pulser and the digital output X1.

Connection: Artificial neutral (delta connection) zigzag transformer

If no star point is available, the following circuit can create an artificial neutral.

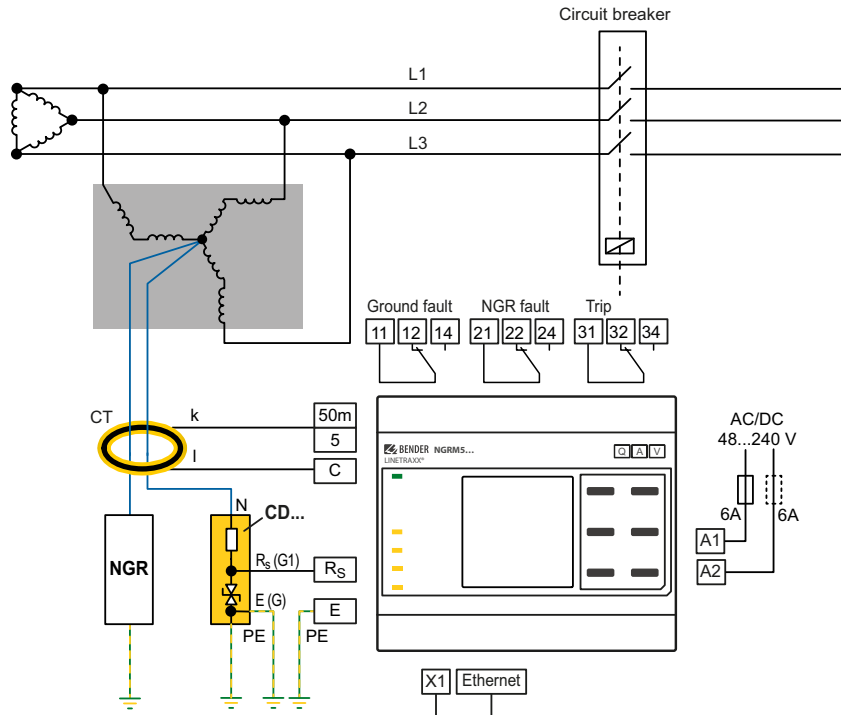

Connectors CD...

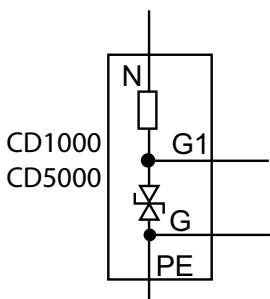



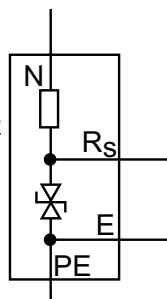

CD1000-2
CD14400
CD25000

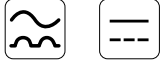

- N** Connection to star point
- G1, RS** Connection to R_s of the NGRM5...
- G, E** Connection to E of the NGRM5...
- PE** Connection to the protective earth conductor of the installation (PE)

Measuring current transformer connection

Depending on the system to be monitored, a suitable measuring current transformer has to be chosen. All common measuring current transformers (50 mA or 5 A on the secondary side) can be used. The following table helps you with the choice:

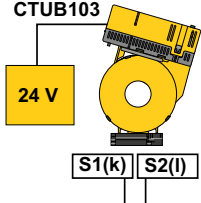
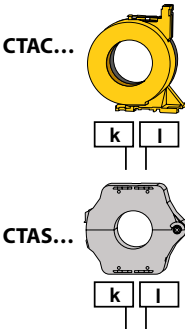
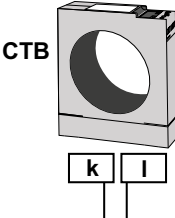
System type	AC + DC	AC	AC	AC
I_{NGR}	0,5...25 A	5...25 A	5...1000 A	10...2000 A
f	0...3800 Hz	42...3800 Hz	50/60 Hz	50/60 Hz
Transformation ratio Bender measuring current transformer	Measuring range (see CTUB103 manual) 5 A 100:1 10 A 200:1 25 A 500:1	600:1		
Connecting cable	max. 30 m provided cable or 0.75...1.5 mm ² /AWG18...16	max. 40 m	max. 25 m (4 mm ² /AWG12) max. 40 m (6 mm ² /AWG10)	
$I_{\Delta n}$				
Type	<p>CTUB103</p> 	<p>CTAC... / CTAS...</p> 	<p>CTB31...51</p> 	Any standard current transformer can be used.
CT: Terminal k	NGRM5...: 50 mA	NGRM5...: 50 mA	NGRM5...: 5 A	NGRM5...: 5 A
CT: Terminal l	NGRM5...: C	NGRM5...: C	NGRM5...: C	NGRM5...: C

Connection of relays (ground-fault, NGR-fault and trip relay)

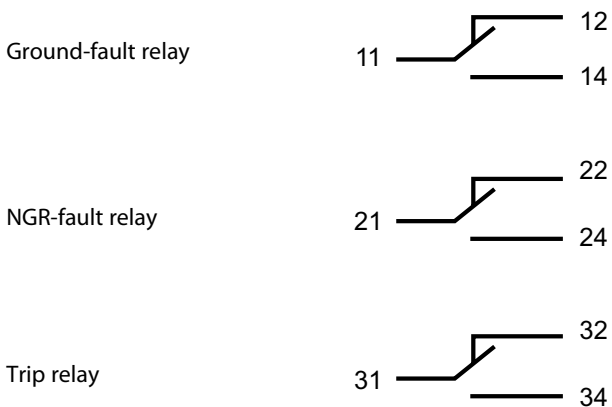

The delay times of the various relays are not the same. See table „Trip times relays“ in the manual.

Connection to the X1 interface

Pin assignment X1 interface

	I1	Digital 1 (configurable: pulser, NGR method)
	I2	Reset IN
	I3	Test IN
	A	Modbus RTU (A)
	B	Modbus RTU (B)
	⊥	Common
	M+	Analogue output
	Q2	Open Collector: Pulser OUT
	Q1	Open Collector: Device condition (Device health)
	+	Output for supply of external relays (+24 V, max. 100 mA)

X1: Input I1...3

The input is only detected as “activated” after the contact has been activated for at least 150 ms. This way, short interference pulses are ignored.

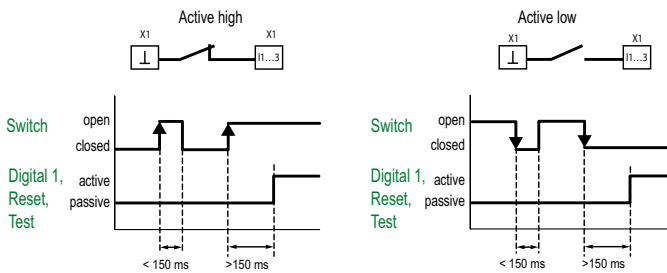

Input I1...3: Potential-free contact to common or 0 V and 24 V in conjunction with a PLC

X1: Output Q1...2

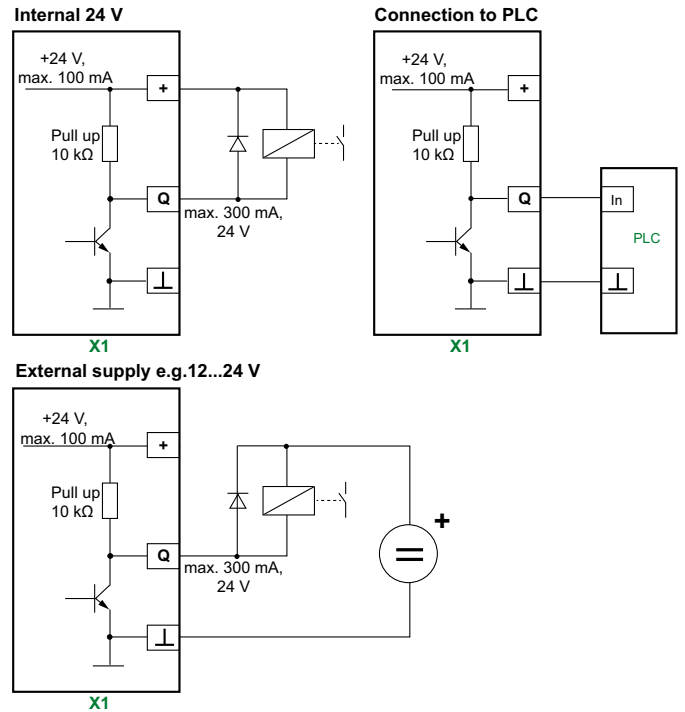

Connection to Q1, Q2: external relay or PLC.

i Observe maximum current values!
 The maximum **output current** on X1 (+24 V) is **100 mA**. In case of higher currents, the relays require an external 24-V supply. The maximum current on **Q1 and Q2** is **300 mA** each.

X1: Analogue output

Analogue output	Mode	Permissible load
	0...20 mA	≤ 600 Ω
	4...20 mA	≤ 600 Ω
	0...400 μA	≤ 4 kΩ
	0...10 V	≥ 1 kΩ
	2...10 V	≥ 1 kΩ

Technical Data
Insulation coordination according to IEC 60664-1/IEC 60664-3/DIN EN 50178

Definitions	
Supply circuit (IC1)	(A1, A2)
Measuring circuit/Control circuit (IC2)	(RS, E, CT), (X1, ETH)
Output circuit 1 (IC3)	(11, 12, 14)
Output circuit 2 (IC4)	(21, 22, 24)
Output circuit 3 (IC5)	(31, 32, 34)
Rated voltage	250 V
Overvoltage category	III
Rated impulse voltage	
IC1/(IC2...5)	4 kV
IC2/(IC3...5)	4 kV
IC3/(IC4...5)	4 kV
IC4/(IC5)	4 kV
Rated insulation voltage	
IC1/(IC2...5)	250 V
IC2/(IC3...5)	250 V
IC3/(IC4...5)	250 V
IC4/(IC5)	250 V
Pollution degree exterior	3
Safe isolation (reinforced insulation) between	
IC1/(IC2...5)	overvoltage category III, 300 V
IC2/(IC3...5)	overvoltage category III, 300 V
IC3/(IC4...5)	overvoltage category III, 300 V
IC4/(IC5)	overvoltage category III, 300 V
Voltage tests (routine test) acc. to IEC 61010-1	
IC1/(IC2...5)	AC 2.2 kV
IC2/(IC3...5)	AC 2.2 kV
IC3/(IC4...5)	AC 2.2 kV
IC4/(IC5)	AC 2.2 kV

Supply voltage

Nominal supply voltage U_s	AC/DC, 48...240 V
for UL applications	AC/DC, 48...240 V
for AS/NZS 2081 applications	AC/DC, 48...230 V
Tolerance U_s	$\pm 15\%$
Tolerance U_s (for UL applications)	$-50...+15\%$
Tolerance U_s (for AS/NZS 2081 applications)	$-25...+20\%$
Frequency range U_s	DC, 40...70 Hz
Power consumption (max.)	$\leq 7\text{ W} / 16\text{ VA}$

Monitoring R_{NGR}

Measuring input R_S	$< 33\text{ V RMS}$
Measuring range NGR (with $R_S = 20\text{ k}\Omega$) active	0...10 k Ω
Measurement uncertainty for $T = 0...+40\text{ }^\circ\text{C}$	$\pm 20\text{ }\Omega$
Measurement uncertainty for $T = -40...+70\text{ }^\circ\text{C}$	$\pm 40\text{ }\Omega$
Measuring range NGR (with $R_S = 100\text{ k}\Omega$) active	0...10 k Ω
Measurement uncertainty for $T = 0...+40\text{ }^\circ\text{C}$	$\pm 30\text{ }\Omega$
Measurement uncertainty for $T = -40...+70\text{ }^\circ\text{C}$	$\pm 80\text{ }\Omega$
HRG	
Setting range $R_{NGR\text{ nom}}$	15 Ω ...5 k Ω
Response value $< R_{NGR\text{ nom}}$	10...90 % $R_{NGR\text{ nom}}$
Response value $> R_{NGR\text{ nom}}$	110...200 % $R_{NGR\text{ nom}}$
LRG	
Setting range $R_{NGR\text{ nom}}$	0.1...200 Ω
Response value $> R_{NGR\text{ nom}}$	200...500 Ω
Response delay, NGR-fault relay	7 s ($\pm 2.5\text{ s}$)
Response delay, trip relay	0...48 h

Monitoring I_{NGR}

Measuring circuit 5 A	
Nominal measuring current I_n	DC / 50/60 Hz / 10...3200 Hz 5 A
Maximum continuous current	$2 \times I_n$
Overload capacity	10 x I_n for 0.03 s
Measurement accuracy	$\pm 2\%$ of I_n
Load	10 m Ω
Measuring circuit 50 mA	
Nominal measuring current I_n	DC / 50/60 Hz / 10...3200 Hz 50 mA
Maximum continuous current	$2 \times I_n$
Overload capacity	10 x I_n for 2 s
Measurement accuracy	$\pm 2\%$ of I_n
Load	68 Ω
Measuring circuits 5 A and 50 mA	
Response value I_{NGR}	10...90 % $I_{NGR\text{ nom}}$
Response delay, ground-fault relay	$\leq 40\text{ ms}$ ($\pm 10\text{ ms}$)
Response delay, trip relay (configurable)	100 ms...48 h, ∞
Tolerance t_{trip} when set to	
RMS	$-20...0\text{ ms}$
Fundamental	0...+150 ms (filter time)
Harmonics	0...+150 ms (filter time)
Measuring current transformer ratio primary	1...10,000
Measuring current transformer ratio secondary	1...10,000
Measuring range	$2 \times I_{NGR\text{ nom}}$

Coupling

R_S for $U_{\text{sys}} \leq 4.3\text{ kV}$	CD1000, CD1000-2, CD5000 (20 k Ω)
R_S for $U_{\text{sys}} > 4.3\text{ kV}$	CD14400, CD25000 (100 k Ω)

Monitoring U_{NGR}

U_{NGR} with $R_S = 20\text{ k}\Omega$	DC / 50/60 Hz / 10...3200 Hz; $(400/\sqrt{3}) \dots \leq (4300/\sqrt{3})\text{ V}$
U_{NGR} with $R_S = 100\text{ k}\Omega$	DC / 50/60 Hz / 10...3200 Hz; $> (4.3/\sqrt{3}) \dots (25/\sqrt{3})\text{ kV}$
Measuring range	$1.2 \times U_{NGR\text{ nom}}$
Overload capacity	$2 \times U_{NGR}$ for 10 s
Measurement accuracy	2 % of $U_{NGR\text{ nom}}$ with $U_{NGR\text{ nom}} = (U_{\text{sys(L-L)}}/\sqrt{3})$
Voltage response value	10...90 % $U_{NGR\text{ nom}}$
Response delay, ground-fault relay	$\leq 40\text{ ms}$ ($\pm 10\text{ ms}$)
Response delay, trip relay (configurable)	100 ms...48 h, ∞
Tolerance trip when set to	
RMS	$-20...0\text{ ms}$
Fundamental	0...+150 ms (filter time)
Harmonics	0...+150 ms (filter time)
DC immunity in case of active R_{NGR} measurement	
with $R_S = 20\text{ k}\Omega$	DC $\pm 12\text{ V}$
with $R_S = 100\text{ k}\Omega$	DC $\pm 60\text{ V}$

Digital inputs

Galvanic separation	no
Length connecting cables	max. 10 m
U_{in}	DC 0 V, 24 V
Overload capacity	$-5...32\text{ V}$

Digital outputs

Galvanic separation	no
Length connecting cables	max. 10 m
Currents (sink) for each output	max. 300 mA
Voltage	24 V
Overload capacity	$-5...32\text{ V}$

Analogue output (M+)

Operating principle	linear
Functions	I_{NGR}, R_{NGR}
Current	0...20 mA ($\leq 600 \Omega$), 4...20 mA ($\leq 600 \Omega$), 0...400 μ A ($\leq 4 \text{ k}\Omega$)
Voltage	0...10 V ($\geq 1 \text{ k}\Omega$), 2...10 V ($\geq 1 \text{ k}\Omega$)
Tolerance related to the current/voltage end value	$\pm 20 \%$

Ground-fault, NGR, trip relay

Switching elements	changeover contacts
Operating mode	configurable fail-safe/non-fail-safe
Electrical endurance, number of cycles	10,000
Switching capacity	2000 VA / 150 W

Contact data acc. to IEC 60947-5-1

Rated operational voltage AC	250 V/250 V
Utilisation category	AC-13/AC-14
Rated operational current AC	5 A/3 A
Rated operational current AC (for UL applications)	3 A/3 A
Rated operational voltage DC	220/110/24 V
Utilisation category	DC12
Rated operational current DC	0.1/0.2/1 A
Minimum current	1 mA at AC/DC > 10 V

Environment/EMC

EMC immunity (IEC 61000-6-2 / IEC 60255-26 Ed. 3.0)	DIN EN 61000-6-2
EMC emission (IEC 61000-6-4 / IEC 60255-26 Ed. 3.0)	DIN EN 61000-6-4
Operating temperature	-40...+60 °C
Operating temperature for UL applications	-40...+60 °C
Transport	-40...+85 °C
Long-term storage	-40...+70 °C
Humidity	$\leq 98 \%$

Classification of climatic conditions acc. to IEC 60721

(with respect to temperature and rel. humidity)	
Stationary use (IEC 60721-3-3)	3K22
Transport (IEC 60721-3-2)	2K11
Long-term storage (IEC 60721-3-1)	1K22

Classification of mechanical conditions acc. to IEC 60721 / IEC 60255-21 / DIN EN 60068-2-6

Stationary use	3M7
Transport	2M4
Long-term storage	1M12

Connection

Screw-type terminals

Tightening torque	0.5...0.6 Nm (5...7 lb-in)
Stripping length	7 mm
Recommended connecting cables	see overview in the manual
rigid/flexible	0.2...2.5 mm ² (AWG 24...13)
flexible with ferrule with/without plastic sleeve	0.25...2.5 mm ² (AWG 24...13)
Multiple conductor rigid	0.2...1 mm ² (AWG 24...18)
Multiple conductor flexible	0.2...1.5 mm ² (AWG 24...16)
Multiple conductor, flexible with ferrule without plastic sleeve	0.25...1 mm ² (AWG 24...18)
Multiple conductor, flexible with TWIN ferrule with plastic sleeve	0.5...1.5 mm ² (AWG 21...16)

Push-wire terminal X1

Stripping length	10 mm
rigid/flexible	0.2...1.5 mm ² (AWG 24...16)
flexible with ferrule without plastic sleeve	0.25...1.5 mm ² (AWG 24...16)
flexible with ferrule with plastic sleeve	0.25...0.75 mm ² (AWG 24...18)

Other

Operating mode	continuous operation
Mounting	display-oriented
Operating altitude	$\leq 2000 \text{ m AMSL}$
Degree of protection, internal components (DIN EN 60529)	IP30
Flammability class	UL 94V-0
Protective coating measurement equipment	SL1307, UL file E80315
Documentation number	D00373
Weight	< 500 g

Dimension diagram NGRM5...

Dimensions in mm (in)

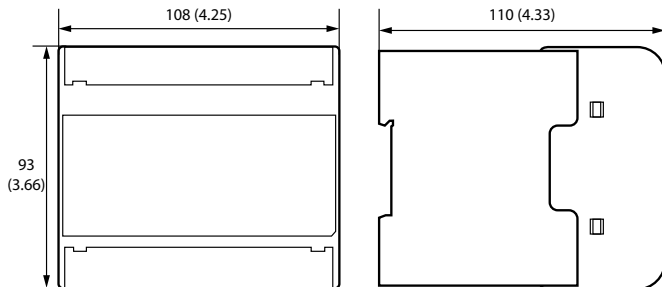

Ordering information

Type	System type	Supply voltage U_s / Frequency range Hz	Art. No.
NGRM500	HRG	AC 48...240 V, 40...70 Hz DC 48...240 V	B94013500
NGRM550	LRG		B94013550

Suitable system components

Description	Voltage/Current	Type	Art. No.
Measuring current transformer	AC up to 30 A	CTAC35	B98110007
		CTAC60	B98110017
		CTAS50	B98110009
		CTAS80	B98110010
		CTAS120	B98110011
	AC/DC up to 10 A	CTUB103-CTBC35	B78120030
	AC/DC up to 25 A	CTUB103-CTBC60	B78120031
		CTUB103-CTBC120	B78120032
AC >30...1000 A	CTB31...CTB51	B980860xx ¹⁾	

Description	Length (m)	Type	Art. No.
Connecting cables CTUB103	1	CTXS-100	B98110090
	2,5	CTXS-250	B98110091
	5	CTXS-500	B98110092
	10	CTXS-1000	B98110093

Description	max. connected measuring current transformers	Type	Art. No.
Voltage supply for AC/DC measuring current transformers CTUB103...	2	STEP-PS/1 AC/24 DC/0.5	B94053110
	7	STEP-PS/1 AC/24 DC/1.75	B94053111
	17	STEP-PS/1 AC/24 DC/4.2	B94053112

¹⁾ All types and ordering informations of this series are available on our website

Description	Voltage U_{sys}	Type	Art. No.
CD-series coupling device	400...690 V	CD1000	B98039010
	400...1000 V	CD1000-2	B98039053
	1000...4200 V	CD5000	B98039011
	4300...14550 V	CD14400	B98039054
	14551...25000 V	CD25000	B98039055



Bender GmbH & Co. KG • Germany
Londorfer Straße 65 • 35305 Grünberg
Tel.: +49 6401 807-0 • info@bender.de
www.bender.de

USA, Mexico, Central America • Exton PA, USA
800.356.4266 / 610.383.9200 • info@bender.org
www.bender.org

Canada • Mississauga ON, Canada
800.243.2438 / 905.602.9990
info@bender-ca.com • www.bender-ca.com

South America • Santiago de Chile
+59 2.2933.4211 • info@bender-latinamerica.com
www.bender-latinamerica.com



© Bender GmbH & Co. KG, Germany
Subject to change!
The specified standards take into
account the edition valid until 06.2023
unless otherwise indicated.